



Operator's Manual

B-Series Units with Direct Smart Reefer

B-100, B-100 ECO, B-100 MAX

Revision A

Introduction

This manual is published for informational purposes only and the information furnished herein should not be considered as all-inclusive or meant to cover all contingencies. If more information is required, consult your Thermo King Service Directory for the location and telephone number of the local dealer.

Thermo King's warranty shall not apply to any equipment which has been "so installed, maintained, repaired or altered as, in the manufacturer's judgment, to affect its integrity."

Manufacturer shall have no liability to any person or entity for any personal injury, property damage or any other direct, indirect, special, or consequential damages whatsoever, arising out of the use of this manual or any information, recommendations or descriptions contained herein. The procedures described herein should only be undertaken by suitably qualified personnel. Failure to implement these procedures correctly may cause damage to the Thermo King unit or other property or personal injury.

There is nothing complicated about operating and maintaining your Thermo King unit, but a few minutes studying this manual will be time well spent.

Performing pre-trip checks and enroute inspections on a regular basis will minimize operating problems. A regular maintenance program will also help to keep your unit in top operating condition. If factory recommended procedures are followed, you will find that you have purchased the most efficient and dependable temperature control system available.

All service requirements, major and minor, should be handled by a Thermo King dealer for four very important reasons:

- They are equipped with the factory recommended tools to perform all service functions
- They have factory trained and certified technicians
- They have genuine Thermo King replacement parts
- The warranty on your new unit is valid only when the repair and replacement of component parts is performed by an authorized Thermo King dealer

Software License

The product includes software that is licensed under a non-exclusive, non-sublicensable, terminable and limited license to use the software as installed

on the product for its intended purpose. Any removal, reproduction, reverse engineering, or other unauthorized use of the software is strictly prohibited. Hacking the product or installing unapproved software may void the warranty. The owner or operator shall not reverse engineer, decompile, or disassemble the software, except and only to the extent that such activity is expressly permitted by applicable law notwithstanding this limitation. The product may include third party software separately licensed as specified in any documentation accompanying the product or in an about screen on a mobile application or website that interfaces with the product.

Emergency Assistance

Thermo Assistance is a multi-lingual communication tool designed to put you in direct contact with an authorized Thermo King dealer.

Thermo Assistance should only be contacted for breakdown and repair assistance.

To use this system, you need the following information before you call:
(phone charges will apply)

- Contact Phone Number
- Type of TK Unit
- Thermostat Setting
- Present Load Temperature
- Probable Cause of Fault
- Warranty Details of the Unit
- Payment Details for the Repair

Leave your name and contact number and a Thermo Assistance Operator will call you back. At this point you can give details of the service required and the repair will be organized.

Please note that Thermo Assistance cannot guarantee payments and the service is designed for the exclusive use of refrigerated transporters with products manufactured by Thermo King Corporation.



Belgium	+32 270 01 735
Denmark	+45 38 48 76 94
France	+33 171 23 05 03
Germany	+49 695 00 70 740
Italy	+39 02 69 63 32 13
Spain	+34 914 53 34 65
The Netherlands	+31 202 01 51 09
United Kingdom	+44 845 85 01 101
Kazakhstan	+7 7273458096
Russia	+7 4992718539
Others	+32 270 01 735

BEA261

General Inquires and Unit Maintenance

For general inquiries please contact your local Thermo King dealer.

Go to www.europe.thermoking.com and select dealer locator for your local Thermo King dealer.

Or refer to the Thermo King Service Directory for contact information.

Customer Satisfaction Survey

Let your voice be heard!

Your feedback will help improve our manuals. The survey is accessible through any internet-connected device with a web browser.

Scan the Quick Response (QR) code or click or type the web address https://tranetechnologies.iad1.qualtrics.com/jfe/form/SV_2octfSHoUJxsk6x?Q_CHL=qr&Q_JFE=qdg to complete the survey.



Table of Contents

Safety Precautions	9
Danger, Warning, Caution, and Notice	9
General Safety Practices	10
Automatic Start/Stop Operation	11
Battery Installation and Cable Routing	11
Refrigerant	13
Refrigerant Oil	14
First Aid	14
Safety Decals	16
Service	16
Operation	17
High Voltage	17
High Temperature	17
Condenser and Evaporator Fans	18
Remote Start of the Unit	18
Refrigerant	19
Type Certification	20
Unit Description	21
Standard Unit Features	21
Options	22
System Components	22
Compressor(s)	22
Condenser	22
Evaporator	23
Electronic Control System	23
Description	23
Unit Controls	26
Standby Operation (Models 20 and 50 Only)	27

Electrical System	28
Fuses	28
Pharma	29
Operating Instructions	30
General Operation	30
Starting the Unit	31
Engine Operation	31
Electric Standby Operation	31
Standard Display	32
Single Temperature Units	32
Entering Setpoint Temperature	32
Single Temperature Units	32
Initiating the Evaporator Manual Defrost Cycle	33
Alarms	34
Manual Start	34
Auto Start	35
Buzzers	36
Alarm Code Descriptions	36
Clearing Alarm Codes	37
Viewing Information Screens	38
Main Menu	38
Hourmeter Menu	38
Loading and Inspection Procedures	39
Post-Start Inspection	39
Loading Procedure	39
Post Load Procedure	39

Table of Contents

Specifications	41
Refrigeration System	41
Compressor	41
Electrical Control System	41
Warranty	43
Inspection and Service Intervals	44
Warranty Inspection	44
Weekly Pretrip Inspection	44
Weekly Post-Trip Checks	46
Inspection and Service Schedules	46
Service Record	47
Preventative Maintenance	47
Serial Number Locations	48
Recover Refrigerant	49

Safety Precautions

Danger, Warning, Caution, and Notice

Thermo King® recommends that all service be performed by a Thermo King dealer and to be aware of several general safety practices.

Safety advisories appear throughout this manual as required. Your personal safety and the proper operation of this unit depend upon the strict observance of these precautions.

DANGER

Indicates an imminently hazardous situation which, if not avoided, will result in death or serious injury.

WARNING

Indicates a potentially hazardous situation which, if not avoided, could result in death or serious injury.

CAUTION

Indicates a potentially hazardous situation which, if not avoided, could result in minor or moderate injury and unsafe practices.

NOTICE

Indicates a situation that could result in equipment or property-damage only accidents.

General Safety Practices



⚠ DANGER

Risk of Injury!

Keep hands and loose clothing clear of fans and belts at all times when the unit is operating with the doors open.

⚠ WARNING

Risk of Injury!

Do not apply heat to a closed cooling system. Before applying heat to a cooling system, drain it. Then flush it with water and drain the water. Antifreeze contains water and ethylene glycol. The ethylene glycol is flammable and can ignite if the antifreeze is heated enough to boil off the water.

⚠ WARNING

Risk of Injury!

Temperatures above 120 degrees F (50 degrees C) can cause serious burns. Use an infrared thermometer or other temperature measuring device before touching any potentially hot surfaces.

⚠ CAUTION

Sharp Edges!

Exposed coil fins can cause lacerations. Service work on the evaporator or condenser coils is best left to a certified Thermo King technician.

Automatic Start/Stop Operation



⚠ CAUTION

Risk of Injury!

The unit can start and run automatically any time the unit is turned on. Turn the Microprocessor On/Off switch Off before doing inspections or working on any part of the unit. Please note that only Qualified and Certified personnel should attempt to service your Thermo King unit.

Battery Installation and Cable Routing



⚠ WARNING

Hazard of Explosion!

An improperly installed battery could result in a fire, explosion, or injury. A Thermo King approved battery must be installed and properly secured to the battery tray.

⚠ WARNING

Hazard of Explosion!

Improperly installed battery cables could result in a fire, explosion, or injury. Battery cables must be installed, routed, and secured properly to prevent them from rubbing, chaffing, or making contact with hot, sharp, or rotating components.

Safety Precautions**⚠ WARNING****Fire Hazard!**

Do not attach fuel lines to battery cables or electrical harnesses. This has the potential to cause a fire and could cause serious injury or death.

**⚠ WARNING****Personal Protective Equipment (PPE) Required!**

A battery can be dangerous. A battery contains a flammable gas that can ignite or explode. A battery stores enough electricity to burn you if it discharges quickly. A battery contains battery acid that can burn you. Always wear goggles or safety glasses and personal protective equipment when working with a battery. If you get battery acid on you, immediately flush it with water and get medical attention.

⚠ WARNING**Hazard of Explosion!**

Always cover battery terminals to prevent them from making contact with metal components during battery installation. Battery terminals grounding against metal could cause the battery to explode.

⚠ CAUTION**Hazardous Service Procedures!**

Set all unit electrical controls to the OFF position before connecting battery cables to the battery to prevent unit from starting unexpectedly and causing personal injury.

NOTICE**Equipment Damage!**

Do not connect other manufacturer's equipment or accessories to the unit unless approved by Thermo King. Failure to do so can result in severe damage to equipment and void the warranty.

Refrigerant



Although fluorocarbon refrigerants are classified as safe, use caution when working with refrigerants or in areas where they are being used.

▲ DANGER

Hazardous Gases!

Refrigerant in the presence of an open flame, spark, or electrical short produces toxic gases that are severe respiratory irritants which can cause serious injury or possible death.

▲ DANGER

Refrigerant Vapor Hazard!

Do not inhale refrigerant. Use caution when working with refrigerant or a refrigeration system in any confined area with a limited air supply. Refrigerant displaces air and can cause oxygen depletion, resulting in suffocation and possible death.

▲ WARNING

Personal Protective Equipment (PPE) Required!

Refrigerant in a liquid state evaporates rapidly when exposed to the atmosphere, freezing anything it contacts. Wear butyl lined gloves and other clothing and eye wear when handling refrigerant to help prevent frostbite.

Refrigerant Oil



Observe the following precautions when working with or around refrigerant oil:

⚠ WARNING

Personal Protective Equipment (PPE) Required!

Protect your eyes from contact with refrigerant oil. The oil can cause serious eye injuries. Protect skin and clothing from prolonged or repeated contact with refrigerant oil. To prevent irritation, wash your hands and clothing thoroughly after handling the oil. Rubber gloves are recommended.

First Aid

REFRIGERANT

- **Eyes:** For contact with liquid, immediately flush eyes with large amounts of water and get prompt medical attention.
- **Skin:** Flush area with large amounts of warm water. Do not apply heat. Remove contaminated clothing and shoes. Wrap burns with dry, sterile, bulky dressing to protect from infection. Get prompt medical attention. Wash contaminated clothing before reuse.
- **Inhalation:** Move victim to fresh air and use Cardio Pulmonary Resuscitation (CPR) or mouth-to-mouth resuscitation to restore breathing, if necessary. Stay with victim until emergency personnel arrive.
- **Frost Bite:** In the event of frost bite, the objectives of First Aid are to protect the frozen area from further injury, warm the affected area rapidly, and to maintain respiration.

REFRIGERANT OIL

- **Eyes:** Immediately flush with large amounts of water for at least 15 minutes. Get prompt medical attention.
- **Skin:** Remove contaminated clothing. Wash thoroughly with soap and water. Get medical attention if irritation persists.

- **Inhalation:** Move victim to fresh air and use Cardio Pulmonary Resuscitation (CPR) or mouth-to-mouth resuscitation to restore breathing, if necessary. Stay with victim until emergency personnel arrive.
- **Ingestion:** Do not induce vomiting. Immediately contact local poison control center or physician.

ENGINE COOLANT

- **Eyes:** Immediately flush with large amounts of water for at least 15 minutes. Get prompt medical attention.
- **Skin:** Remove contaminated clothing. Wash thoroughly with soap and water. Get medical attention if irritation persists.
- **Ingestion:** Do not induce vomiting. Immediately contact local poison control center or physician.

BATTERY ACID

- **Eyes:** Immediately flush with large amounts of water for at least 15 minutes. Get prompt medical attention. Wash skin with soap and water.

ELECTRICAL SHOCK

Take IMMEDIATE action after a person has received an electrical shock. Get quick medical assistance, if possible.

The source of the shock must be quickly stopped, by either shutting off the power or removing the victim. If the power cannot be shut off, the wire should be cut with a non-conductive tool, such as a wood-handle axe or thickly insulated cable cutters. Rescuers should wear insulated gloves and safety glasses, and avoid looking at wires being cut. The ensuing flash can cause burns and blindness.

If the victim must be removed from a live circuit, pull the victim away with a non-conductive material. Use wood, rope, a belt or coat to pull or push the victim away from the current. **DO NOT TOUCH** the victim. You will receive a shock from current flowing through the victim's body. After separating the victim from power source, immediately check for signs of a pulse and respiration. If no pulse is present, start Cardio Pulmonary Resuscitation (CPR). If a pulse is present, respiration might be restored by using mouth-to-mouth resuscitation. Call for emergency medical assistance.

ASPHYXIATION

Move victim to fresh air and use Cardio Pulmonary Resuscitation (CPR) or mouth-to-mouth resuscitation to restore breathing, if necessary. Stay with victim until emergency personnel arrive.

Safety Decals

Service

The Service decal is located in an appropriate location internally. This decal gives you the information to access/download your unit operator manual, but also the safety icons associated with your unit. These safety icons are directly associated with the information within this chapter. You can see the explanations for these icons starting from the beginning of this chapter.

Note: This decal only contains symbols of warning for the service of the unit.

Figure 1. Service Decal

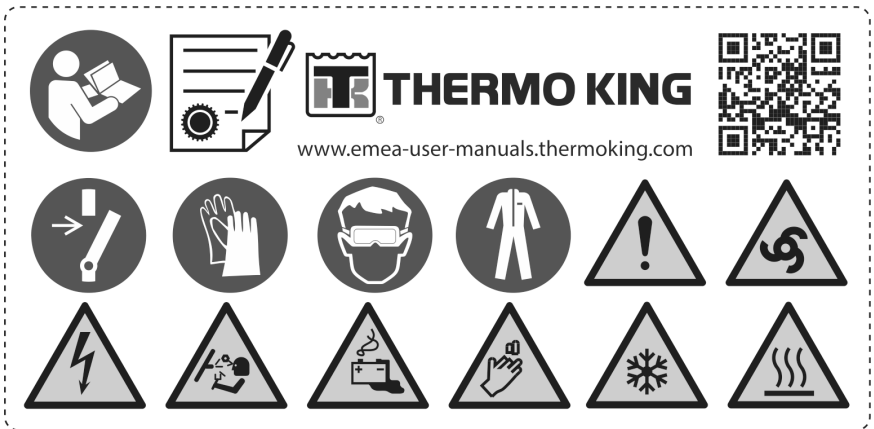

BEN896

Operation

The Operation decal is located in an appropriate position near your in-cab controller (HMI). This decal gives you the information to access/download your unit operator manual and other supporting documentation and in many supported languages.

Figure 2. Operation Decal



BEN525

High Voltage

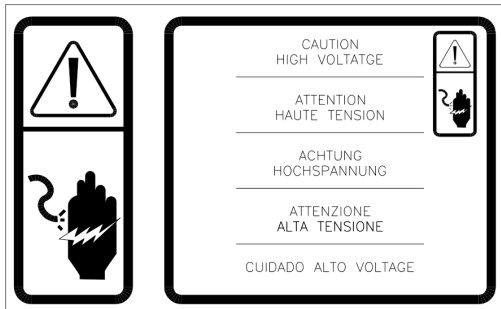

SAP1263

- In the control box.



BEA237

High Temperature

This decal used in evaporators ES100 with AC heaters

Figure 3. High Temperature Warning

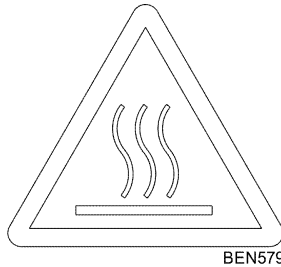

Condenser and Evaporator Fans

Be aware of the warning nameplates () in the following locations:

- On belt guard
- On rear of evaporator housing

Figure 4. Fan Warning

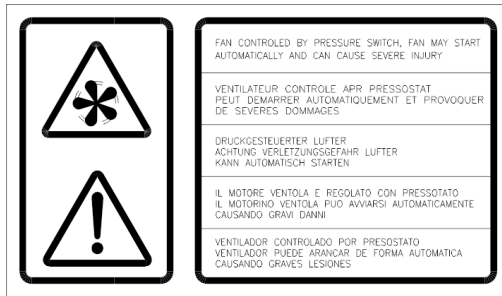

BEN580

Remote Start of the Unit

⚠ CAUTION

Risk of Injury!

The unit can start and run automatically any time the unit is turned on. Turn the Microprocessor On/Off switch Off before doing inspections or working on any part of the unit. Please note that only Qualified and Certified personnel should attempt to service your Thermo King unit.

Decals located behind service door.

Figure 5. Unit Auto-start Warning

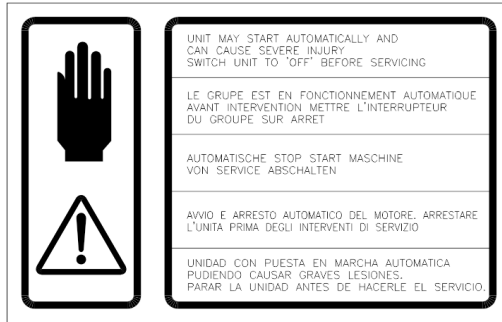

BEN581

Refrigerant

Refrigerant Decal is located adjacent to the service ports for charging or recovering the gas, as per the F-Gas regulation.

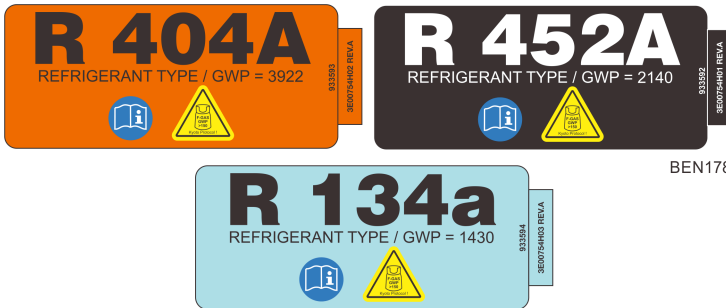

BEN178

F Gas decal indicates that this equipment Contains fluorinated greenhouse gases.



SAP1243

Type Certification

UNECE R10 decal sample.

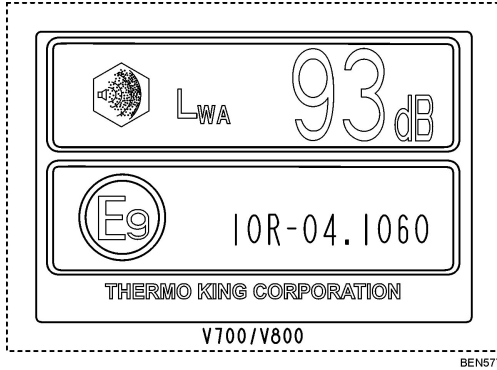

Unit Description

Thermo King Vehicle Powered Truck Units are two-piece units comprised of a condenser and evaporator designed for fresh, frozen, and deep frozen applications on small trucks and vans.

A belt driven compressor powered by the vehicle battery. It provides constant cooling and heating capacity independent of the vehicle engine. Where electric stand-by is required, an AC motor is fitted in the condenser. The aerodynamic condenser can be roof or front mounted, depending on the vehicle body shape.

The user friendly Direct Smart Reefer (DSR) controller makes operating your unit simple, while its modular design allows for ease of service.

B-Series Units Include:

- **B-100. B-100 ECO:** for fresh temperature applications above 0°C.
- **B-100 MAX:** for frozen temperature applications below 0°C and down to -32°C.

There are five basic models :

- **Model 10:** Cool and Defrost with only vehicle powered engine driven compressor operation.
- **Model 20:** Cool and Defrost with both vehicle powered engine driven compressor operation and electric standby compressor operation.
- **Model 30:** Hot gas heat, Cool, and Defrost with only vehicle powered engine driven compressor operation.
- **Model 50:** Hot gas heat, Cool and Defrost with both vehicle powered engine driven compressor operation and electric standby compressor operation.
- **Spectrum:** Multi-Temperature versions of the models above with the cargo area split into zones of different temperature combination settings.

Two add-on heat options are available:

- Coolant Heat (Models 10 and 20 only).
- Coolant and Electric Heat (Model 20 only).

Standard Unit Features

- **Condenser** - Lightweight design of aluminium construction, easy to service with automotive grade polypropylene cover.

Unit Description

- **Evaporator** - Ultra slim design, aluminum construction automotive grade Acrylonitrile Butadiene Styrene (**ABS**) cover.
- **Compressor(s)** - Industry-standard reciprocating compressor that delivers excellent performance in a compact size. For increased reliability and performance.
- **Controls** - User friendly Direct Smart Reefer (DSR) In-Cab controller.
- **Refrigerant** - R-134a, R-452A or R-404A (depending on unit model).

Options

- Electric Standby
- Hot Gas, Electric or Coolant Heating
- Door Switch Kit
- Discharge Muffler Kit
- Snow Covers
- Refrigeration Hose / Harness Covers
- Roof Top Mounting Kit
- TK Tracking
- Electric Standby Plug (115 Vac, 230 Vac 1 phase, 230 Vac 3 phase)

Note: *Some options are available factory installed or as a retro-fit option to suit individual customer needs.*

System Components

The system consists of four main components: compressor, condenser, evaporator, and In-cab control panel (HMI).

Compressor(s)

All B-Series units are battery driven, and therefore there is no need for a compressor in the engine department. Electric standby models however, have an electric motor that operates a reciprocating compressor located inside the condenser.

Condenser

The condenser is located on the roof of the vehicle or on the front of the cargo box. The cover can easily be removed to access the fuses or service the unit.

Figure 6. Condenser



Evaporator

The evaporator is mounted on the ceiling inside the cargo box. The cover can easily be removed for service.

Figure 7. Evaporator



Electronic Control System

The Electronic Control System is composed of an Electronic Control Module (located inside the condenser unit), an interface Board Module, and the HMI. This HMI allows the truck driver to operate the Thermo King refrigeration unit.

Figure 8. HMI

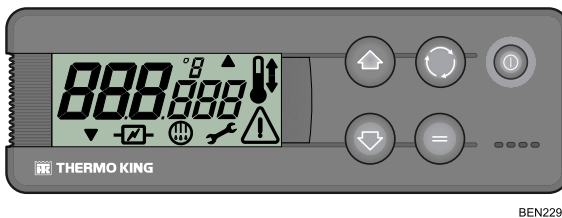

Description

The Electronic Control System has the following characteristics:

- Auto Start
- Soft Start

Unit Description

- Active Display
- Lit Keypad
- Total Hourmeter
- Electric Standby Compressor Hourmeter
- Low Battery Voltage Alarm
- Buzzer
- Unit Control without HMI
- Manual or Automatic Defrost
- Maintenance Warning
- Return Air Temperature Sensor
- Setpoint Temperature Reading
- Electric Power Warning

Auto Start: Should the unit stop due to a failure in the power supply, whether during on-the-road or electric standby operation, it will start up again as soon as the power supply is re-established.

Soft Start: All operation modes remain inactive for a few seconds after an Auto Start.

Active Display: The HMI display is always active and backlit except when the unit is disconnected (no power) or when the unit is connected but has been manually switched off from the HMI (when there is no active alarm).

Lit Keypad: The HMI keys are always lit except when the unit is disconnected (no power) or when the unit is connected but has been manually switched off from the HMI (when there is no active alarm). The On/Off key is always lit except when the unit is disconnected (no power), and thus indicates the presence of power in the unit.

Total Hourmeter: Total number of hours the unit is in operation.

Electric Standby Compressor Hourmeter: Number of hours the unit has been operating in electric standby.

Low Battery Voltage Alarm: Disconnects the unit when the battery voltage falls below 10.5V in 12VDC systems or below 21V in 24VDC systems.

Buzzer: It is energised when the vehicle battery and the electric power supply are connected at the same time. It is also energised if the doors are opened while the refrigeration unit is running.

Unit Control without HMI: The unit can also be operated by the Electronic Control System without the HMI, under conditions selected by the HMI before it is disconnected.

Manual or Automatic Defrost: It is possible to choose between manual or automatic defrost.

Maintenance Warning: On-screen warning of the need to carry out maintenance on the unit.

Return Air Temperature Sensor: On-screen reading of the temperature in the load compartment. In bi-temperature units, the temperature in both compartments can be read on the same screen.

Setpoint Temperature Reading: On-Screen Setpoint Temperature Reading. In bi-temperature units, the setpoint temperature of both compartments can be read on the same screen.

Electric Power Warning: On-screen warning that the unit is connected to an electric power supply.

Unit Controls

⚠ WARNING

Risk of Injury!

Never operate the unit unless you completely understand the controls; otherwise serious injury may occur.

Figure 9. In-cab Control Panel (HMI) Display, Keys, Symbols

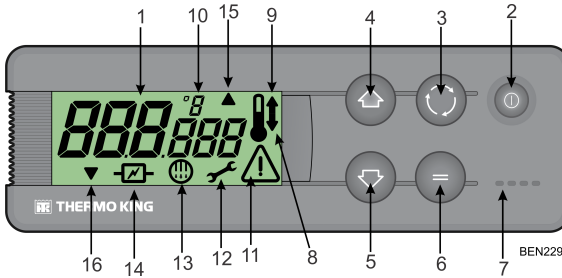

1. Display	It is always active and backlit except when the unit is disconnected (no power) or when the unit is connected but has been manually switched off from the HMI. It normally displays the return air temperature (of both load compartments in multi-temperature units).
2. On/Off Key	This key is used to start/stop the unit. It is always lit except when the unit is disconnected (no power), and thus acts as an indicator of the presence of power in the unit.
3. Select Key	Selects prompt screens and information screens.
4. Up Key	Is used to increase the setpoint temperature.
5. Down Key	Is used to reduce the setpoint temperature.
6. Enter Key	Is used to enter a new command such as manual defrost, etc.
7. Buzzer	It is energised when the vehicle battery and the electric power supply are connected simultaneously. It is also energized if the doors are opened while the refrigeration unit is running.
8. Cool Symbol	(Thermometer with an arrow pointing downward). The unit is cooling.
9. Heat Symbol	(Thermometer with an arrow pointing upward). The unit is heating.
10. °C/°F Symbol	Indicates whether the on-screen temperature reading is in degrees Celsius (C) or degrees Fahrenheit (F).

11. Alarm Symbol	Indicates that there is an alarm in the system.
12. Maintenance Symbol	Warns of the need to carry out maintenance to the unit.
13. Defrost Symbol	Indicates the unit is in Defrost Mode.
14. Electrical Symbol	Indicates that the unit is in Electric Standby.
15. Condenser Defrost Symbol	Indicates the condenser unit is in defrost mode (turns on at the same time as defrost symbol 13).
16. Combined Compartment Symbol	Indicates that the multi-temperature unit is working as a single temperature unit.

Standby Operation (Models 20 and 50 Only)

⚠ WARNING

Hazardous Voltage!

A certified electrician should verify that the proper standby power requirements are being supplied before connecting to a new power source.

These units may be operated in electric standby mode by connecting the proper voltage power cable to the unit's power receptacle mounted on the vehicle. Standby operation is used while the vehicle is stationary with the engine shut off.

Figure 10. Standby Power Receptacle



Electrical System

The unit's controls and refrigeration components operate on 12 Vdc.

Electric Standby units have a standby motor that operates on 115 or 230 Vac when connected to a remote power source. A transformer in the condenser unit converts the 115 or 230 Vac to 12 Vdc to operate the unit's controls and refrigeration components.

Fuses

The electrical components are protected by various fuses.

Main Power Fuse - The main power fuse is located in the vehicle's engine compartment and is connected directly to the vehicle's battery.

This 60 amp in-line fuse is non-serviceable and must only be replaced by an authorized Thermo King Dealer.

Ignition Power Fuse - The ignition power fuse is connected to the vehicle's fused ignition system. Depending on the vehicle, the location of the fuse panel could be located inside the cab or under the hood of the vehicle.

Unit Component Fuses - These fuses are located in the condenser unit. Remove the condenser cover to access them. Depending on your model, some fuses may not be used. Refer to ()Refer to ("[Electrical Control System](#)," p. 41).

Figure 11. Fuse Location (condenser cover removed)

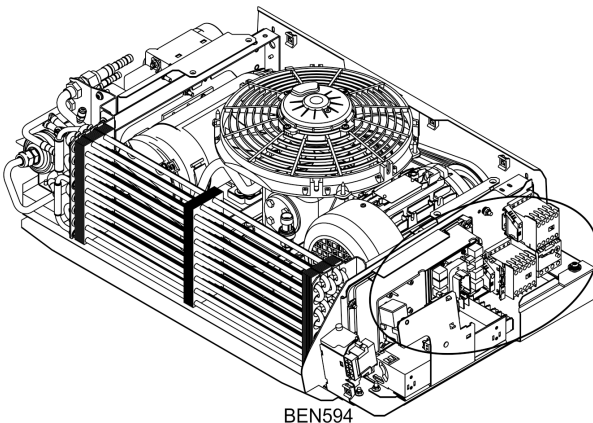

Pharma

Units qualified for pharmaceutical applications under Thermo King protocol are configured with specific Pharma configuration file and parameters loaded during commissioning by your local dealer. Evaporators fans have to run during the Null Cycle.

ThermoKing recommends to run the unit with the recommended Setpoints below:

Table 1. Single Temperature units:

Temperature Range	Recommended Setpoint	Max Deviation Setpoint
Temperature between +15°C and +25°C	+20°C	+1/- 2°C of setpoint
Temperature between 15°C and 25°C	+5°C	+/- 2°C of setpoint

Efficient loading practices and operating procedures have to be followed to ensure optimum air circulation and temperature management.

Operating Instructions

General Operation

In truck-driven units, temperature control is based on two values: The setting (Setpoint) of the electronic thermostat and the evaporator return temperature. The difference between these two temperatures will determine the mode of operation: cool, heat, or null.

- **Cool:** When the temperature in the load compartment is higher than the setpoint, the unit runs in cool mode to reduce the evaporator return temperature.
- **Heat:** When the temperature in the load compartment is lower than the setpoint, the unit changes to heat mode to raise the evaporator return temperature.
- **Null:** Once the Setpoint Temperature has been reached, and while the temperature remains between X°C/F above or below the setpoint, there is no demand for transfer of heat or cold, and the unit runs in null mode.
- **Defrost:** After a scheduled period of time in cool mode, between 1 and 8 hours, the unit runs in this fourth mode of operation to eliminate ice that has accumulated in the evaporator or condenser coil. Defrost can be initiated automatically or manually.

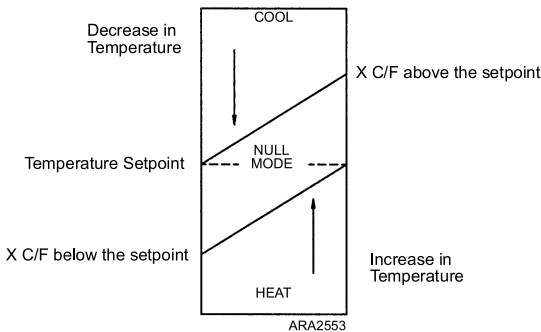

Factory setting for X is 3°C (5°F). During unit installation, this value can be adjusted by between 1 and 5°C (2 and 9°F) in increments of 1°C/F.

Units with R-134a refrigerant: Temperatures can be controlled from -20°C to +22°C (-4°F to +71°F).

Units with R-404A /R-452A refrigerant: Temperatures can be controlled from -32°C to +22°C (-26°F to +71°F).



Address:
Sant Josep, 140-142 P.I. "El Pla",
Sant Feliu de Llobregat,
Barcelona, Spain.

Year of manufacture: Reference Serial Plate.

Installation and commissioning are to be carried out by an authorised Thermo King Dealer in accordance with Thermo King procedures and drawings. Exceptions to this with the written authorisation of the manufacturer only.

Starting the Unit

Engine Operation

1. Start the vehicle.
2. Press the On/Off Key located in the HMI. The HMI display will be activated.
3. Check the setpoint, and adjust if necessary.

Electric Standby Operation

1. Connect the external power supply to the electric power receptacle. Verify the power supply is of the correct voltage and phase for the unit.

⚠ WARNING

Hazardous Voltage!

In case of outdoor conditions, ensure that the connection is made under safe conditions.

2. Press the On/Off Key located in the HMI. The HMI display will be activated. The electric symbol will appear on the screen.
3. Check the setpoint, and adjust if necessary.

Notes:

1. *Regular monitoring of the unit is recommended, the frequency of this monitoring will depend on the type of cargo.*
2. *The operating mode, whether engine-driven or electric standby, is selected automatically. When the unit is connected to an electric power source, engine-driven operation is automatically blocked. If the truck engine is started up while the power cable is still connected to the electrical power source, the unit will continue to operate in electric standby mode and the buzzer will be activated.*

Standard Display

This is the display that appears when the On/Off key is pressed and the unit started. It normally displays the return air temperature (of both load compartments in bi-temperature units) and the current operating mode with the appropriate symbol.

Should there be an alarm, the alarm symbol will also appear on screen.

Single Temperature Units

The example below shows 10.8°C temperature, cool mode, and standby operation.

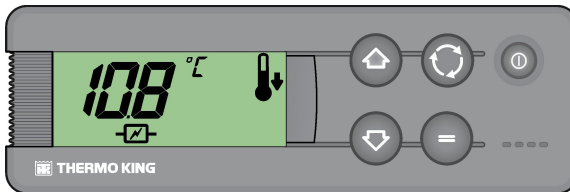

SAP1264

Entering Setpoint Temperature

The Setpoint Temperature can be quickly and easily changed.

Single Temperature Units

1. Press and release the Select key twice, and the current Setpoint Temperature and the letters *SP* will appear on screen.

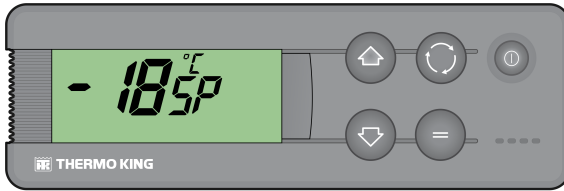

AFV31

2. Press the Up or Down arrow keys to select the desired Setpoint Temperature. Each time either of these buttons is pressed and released, the Setpoint Temperature will change one degree.
3. Press and release the Enter key to set the setpoint or press and release the Select key to set the setpoint and return to the Standard Display.

Important: *If the Select key or the Enter key is not pressed within 20 seconds to select the new Setpoint Temperature, the unit will continue to run at the original Setpoint Temperature.*

Initiating the Evaporator Manual Defrost Cycle

Important: *Before initiating a manual defrost, ensure that the unit is not already in a defrost cycle. When the unit is in a defrost cycle the defrost symbol appears on screen.*

1. Press and release the Select key once, and the letters *dEF* will appear (flashing) on screen along with the present defrost condition *OFF*.

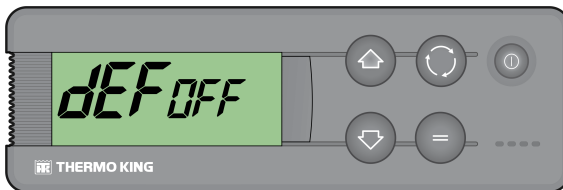

RCS371

2. To activate manual defrost, press the Enter key and then the Up or Down key and the defrost condition will change to *On*.

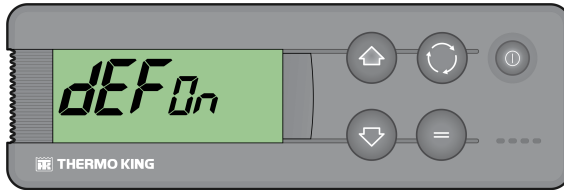

RCS372

3. Press the Select key twice to return to the Standard Display (three times in bi-temperature units and in reverse cycle units), where the letters *dEF* and the DEFROST symbol will appear when the defrost cycle starts (the load compartment temperature must be lower than 0°C).

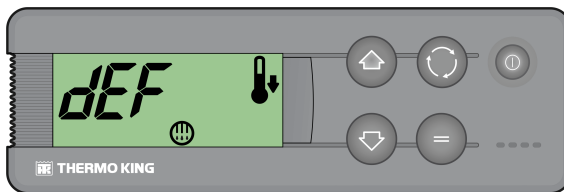

BEN241

Note: The letters *dEF* will remain on screen for a while after returning to cool mode.

Alarms

When the unit is not operating properly, the microprocessor records the alarm code, alerts the operator by displaying the Alarm symbol and, depending on the type of alarm, shuts the unit down.

There are three alarm categories:

Manual Start

The alarm stops the unit, and only the Alarm symbol appears on screen.

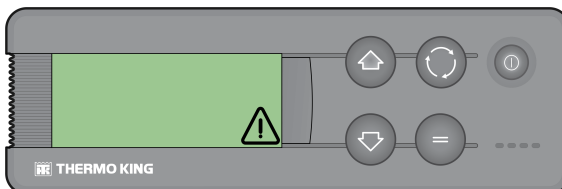

RCS370

Once the alarm condition has been rectified, the On/Off key must be pressed to start up again.

Press and release the Select key to display the current alarm code on screen. If there is more than one active alarm, all the alarm codes on the unit can be viewed in sequence by pressing and releasing the Select key.

Auto Start

The alarm stops the unit, the Alarm symbol appears on screen and the unit starts up automatically once the alarm condition has been rectified.

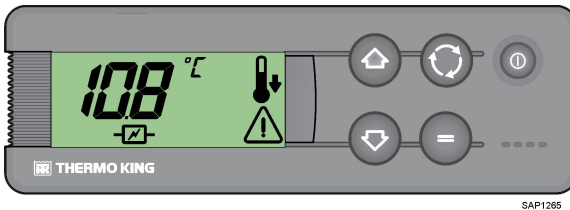

SAP1265

Should a **P1E** alarm occur (return air temperature read error alarm code) appear, — will appear on screen together with the alarm symbol, instead of the return air temperature reading.

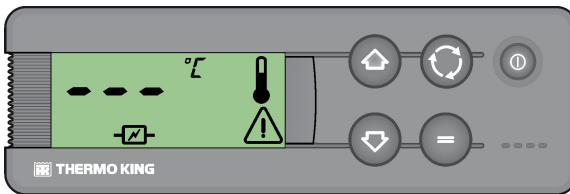

SAP1266

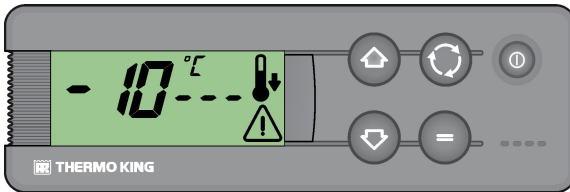

SAP1270

Press and release the Select key to display the current alarm code on screen. If there is more than one active alarm, all the alarm codes on the unit can be viewed in sequence by pressing and releasing the Select key.

Operating Instructions

Buzzers

The buzzers are energized when the vehicle battery and the electrical supply are connected simultaneously (the unit continues running in Standby mode). The buzzers are also energized if the doors open, if this option is selected.

Alarm Code Descriptions

Table 2. Color Code Definitions

OK TO RUN	CHECK AS SPECIFIED	TAKE IMMEDIATE ACTION
Alarm	Description	
Manual Start		
OL		Electric Motor Overload (Electric standby models only) - The electric motor overload relay has tripped due to excessive current draw. <i>If the problem persists when the unit is restarted, contact your Thermo King Dealer.</i>
bAt		Low Battery Voltage - Check vehicle battery.
Auto Start		
HP		High Pressure Alarm - The system has detected excessively high discharge pressure. <i>If the problem persists when the unit is restarted, contact your Thermo King Dealer.</i>
LP		Low Pressure Alarm - The system has detected excessively low suction pressure. <i>If the problem persists when the unit is restarted, contact your Thermo King Dealer.</i>
PSE		High Pressure Sensor Failure - The high pressure sensor has become faulty or disconnected. <i>Contact your Thermo King Dealer.</i>
tEP, tP4		Thermal Protection Alarm - If the problem persists when the unit is restarted, contact your Thermo King Dealer
dr1, dr2		Cargo Doors Are Open (Units with door switch option only) - Check if the Doors are open. if not, then the door switches are faulty, or improper door switch configuration. <i>Contact your Thermo King Dealer.</i>
tCO		Control Module Overheating <i>If the problem persists when the unit is restarted, contact your Thermo King Dealer.</i>

Alarm	Description
SOF	Software Failure Contact your Thermo King Dealer.
P1E	Faulty Cargo Box Return Air Temperature Sensor - Faulty or disconnected return air temperature sensor. Contact your Thermo King Dealer.
C	Communications Failure Contact your Thermo King Dealer.

Clearing Alarm Codes

The alarm condition in the unit must first be corrected. See important note below. After resolving the alarm condition, press and release the Select key to remove existing Alarm codes. The Standard Display will appear once the Alarm codes have been cleared.

To Clear Alarm Codes:

- Correct the cause of the alarm code.
- Press the Select key to remove the alarm code.
- If more than one alarm code is present, press the Select key to clear each alarm code individually.

Important: Continually clearing alarm codes without resolving the problem will result in damage to the unit and compressor.

Notes: The bAt alarm is the unique DSR-III alarm that requires manual confirmation. The DSR-III will keep in OFF condition until the operator acknowledges and the voltage is above the BCH value(factory setting 10.5v).

The way to acknowledge this alarm is as follows:

1. Press the Select key once to show the Alarm screen. You will now see the bAt Alarm code.
2. Press the Select key again to acknowledge the alarm, and Press the select key again and again until the screen returns to the standard Display.

Note: After Clearing all active Compressor Drive Module Alarms, Cdn0 will appear after Acknowledging the Alarm

Viewing Information Screens

Main Menu

From the Standard Display use the Select key to display:

1. Alarms (if any active).
2. Evaporator Manual Defrost.
3. Temperature Setpoint.

Hourmeter Menu

From the Standard Display press the Select key for three seconds to open the Hourmeter Menu, then use the Select key to display:

Note: *For units with firmware version 380.03 and earlier: The unit of measurement is tens of hours (e.g., 150 = 1500 hours). For units with firmware version 380.06 and later: The unit of measurement is hours.*

1. **HC:** Hours remaining to maintenance notice.
2. **tH:** The total amount of time the unit has been switched on protecting the load.
3. **EC:** Electric standby compressor operating hours.
4. Return to Main Menu.

Loading and Inspection Procedures

This chapter describes pre-loading inspections, loading procedures, post-loading procedures, post-loading inspections, and enroute inspections. Thermo King refrigeration units are designed to maintain the required product load temperature during transit. Follow these recommended loading and enroute procedures to help minimize temperature related problems.

Post-Start Inspection

Thermostat: Adjust the thermostat setting to above and below the compartment temperature to check thermostat operation (see Operating Modes).

Pre-cooling: With the thermostat set at the desired temperature, run the unit for half-an-hour to one hour (or longer if possible) before loading the truck. Pre-cooling eliminates residual heat and acts as a good test of the refrigeration system.

Defrost: When the unit has finished pre-cooling the truck interior - the evaporator temperature should have dropped below 2°C (35.6°F) - initiate a defrost cycle with the manual defrost switch. The defrost cycle should stop automatically.

Loading Procedure

1. To minimise frost accumulation in the evaporator coil and a heat increase inside the load compartment, ensure that the unit is OFF before opening the doors (The unit may continue to run when the truck is being loaded in a warehouse with the doors closed).
2. Carefully check and record the load temperature when loading the truck. Note whether any products are out of temperature range.
3. Load the product in such a way that there is sufficient space for the air to circulate throughout the load. DO NOT block the evaporator inlet or outlet.
4. Product should be pre-cooled before loading. Thermo King units are designed to maintain the load at the temperature at which it is loaded. Transport refrigeration units are not designed to reduce the load temperature.

Post Load Procedure

1. Verify all doors are closed and locked.

Loading and Inspection Procedures

2. Adjust the thermostat to the desired temperature setpoint.
3. Start the unit.
4. Half an hour after loading the truck, defrost the unit for a moment by pressing the Manual Defrost switch. If the coil temperature drops to below 2°C (35.6°F), the unit will defrost. The defrost cycle should stop automatically.

Specifications

Refrigeration System

Contact your Thermo King dealer for refrigeration system service or maintenance.

Compressor

Displacement (cc)	47.7
Number of cylinders	6

Electrical Control System

Fuses		
	12 Vdc	24 Vdc
Fuse 1: Main Fuse	100 amps	60 amps
Fuse 3: Evaporator Fan Motor (EFM1)	15 amps	10 amps
Fuse 5: Signals	20 amps	10 amps
Fuse 6: Drain Heaters (H3 and H4)	2 amps	2 amps
Fuse 7: Transformer AC Power Supply 2	10 amps	10 amps
Fuse 14: Vehicle Ignition Switch	5 amps	5 amps
Fuse 20: Transformer AC Power Supply (located at compressor motor contactor in condenser section)	4 amps	4 amps
Fuse 25: Battery Fuse	5 amps	5 amps
Fuse 30: Condenser Fan Motor (CFM) (located in CF1 wire near terminal strip in condenser section)	16 amps	10 amps
Fuse 31: Fuse - Heater 1	20 amps	20 amps
Fuse 32: Fuse - Heater 2	20 amps	20 amps
Fuse 33: Fuse - Heater 3	20 amps	20 amps
Fuse 34: Fuse - Heater 4	20 amps	20 amps

Specifications

Evaporator Fan Motors (Each)		
Voltage	13 Vdc	26 Vdc
Full Load Current	7.5 Amps	4 Amps
Power Rating	97.5 W	104 W
RPM with Full Load	2,800	2,800

AC Electrical Power Supply Motor	
Voltage/Phase/Frequency	230/1/50
Output Power	0.75 kW
Nominal Current Drawn	5.2 amps
OL Relay Adjustment	5.2 amps

DC Electrical Power Supply Motor		
Voltage	12 Vdc	24 Vdc
Output Power	600 W	600 W
Nominal Current Drawn	65 amps	30 amps

Warranty

Please also refer to TK 61654-18-WA Thermo King EMEA Unit Limited Warranty for Vehicle Powered Truck Units.

Inspection and Service Intervals

Inspection and Service intervals are determined by the number of unit operating hours and by the age of the unit. Examples are shown in the table below. Your Dealer will prepare a schedule to suit your specific needs.

Service Record: Each inspection and service performed should be recorded on your Dealer Service Record.

Interim Inspection	Complete PM	Full Service
A Service Every 500 hours or every 6 months (whichever comes first)	B Service Every 1500 hours or every 12 months (whichever comes first)	C Service Every 3000 hours or every 24 months (whichever comes first)

Pretrip	Inspect/Service These Items
•	Listen for unusual noises, vibrations, etc.
•	Visually inspect unit for fluid leaks. (fuel, coolant, oil and refrigerant).
•	Visually inspect unit for damaged, loose or broken parts (includes air ducts and bulkheads if so equipped).
•	Visually inspect belt.
<p>Note: For further best practices, please go to www.europe.thermoking.com/best-practices.</p>	

Warranty Inspection

The unit must be presented at the buyers expense at an authorised Thermo King dealer or service provider for an inspection. The inspection will verify that the unit has been correctly maintained and any upgrades or repairs deemed necessary will be carried out. Subject to a satisfactory inspection, the second twelve months warranty cover will be authorised. This is illustrated in the table above.

Weekly Pretrip Inspection

The following Weekly Pretrip Inspection should be completed before starting the unit and loading the truck. While the weekly inspection is not a substitute for regularly scheduled maintenance inspections, it is important part of the

Inspection and Service Intervals

preventive maintenance program designed to head off operating problems before they happen.

Leaks: Inspect for refrigerant leaks and worn refrigerant lines.

Battery: Terminals should be properly tightened and show no signs of corrosion.

Belts: Inspect for cracks, wear, and proper belt tension.

Mounting Bolts: Verify bolts are properly tightened.

Electrical: Electrical connections should be securely fastened. Wires and terminals should be free of corrosion, cracks, or moisture.

Structural: Visually check for physical damage.

Coils: The condenser and evaporator coils (evaporator coils in bi-temperature units) should be clean and free of debris.

- Washing with clean water should be sufficient. The use of cleaning agents or detergents is strongly discouraged due to the possibility of degradation of the construction. If using a power washer, the nozzle pressure should not exceed 600 psi (41 bar). For the best results, spray the coil perpendicular to the face of the coil. The spray nozzle should be kept between 1 inch and 3 inches (25 to 75 millimetres) from the coil surface. If necessary to use a chemical cleaner or detergent use a cleaner that does not contain any hydrofluoric acids and is between 7 and 8 on the pH scale. Ensure dilution instructions provided by the detergent supplier are followed. In case of doubt about the compatibility of the detergent with the type of materials listed above, always ask the supplier a written confirmation of the compatibility. Should a chemical cleaner be required, it is MANDATORY that all components are thoroughly rinsed with water even if the instructions of the cleaner specify that it is a "no rinse" cleaner. Failure to comply with above mentioned guidelines will lead to a shortened life of the equipment to an indeterminable degree. The repeated transportation of meat and fish waste can cause extensive corrosion to the evaporator coils and evaporator section tubing over time due to ammonia formation and can reduce the lifespan of the coils. Appropriate additional measures should be taken to protect the coils against the aggressive corrosion that can result from transportation of such products.

Load Compartment: Inspect the interior and exterior of the truck for any damage. Any damage to the walls or insulation should be repaired.

Defrost Drains: Check the defrost drain hoses and fittings to ensure they are not blocked.

Inspection and Service Intervals

Doors: Verify doors and weather seals are in good condition and seal hermetically.

Sight glass: Check that the refrigerant charge sight glass on the running unit is totally full (the cargo compartment temperature must be approximately 0°C).

Weekly Post-Trip Checks

NOTICE

Equipment Damage!

Do not use pressurised water.

1. Clean the outside cover of the unit. Use a damp cloth and neutral detergents. Do not use harsh cleaning products or solvents.
2. Check for leaks.
3. Check for loose or missing hardware.
4. Check for physical damage to the unit.

Inspection and Service Schedules

To ensure that your Thermo King unit operates reliably and economically over its full life, and to avoid limiting its warranty cover, the appropriate inspection and service schedule must be followed. Inspection and Service intervals are determined by the number of unit operating hours and by the age of the unit. Examples are shown in the table below. Your Dealer will prepare a schedule to suit your specific needs.

Operat- ing Hours per Year	1000	2000	3000
Inspection	6 months/ 500 hours		
Inspection	12 months/ 1000 hours (+ preventative maintenance)	6 months/ 1000 hours	4 months/ 1000 hours
Inspection	18 months/ 1500 hours	12 months/ 2000 hours (+ preventative maintenance)	8 months/ 2000 hours

Inspection and Service Intervals

Operat- ing Hours per Year	1000	2000	3000
Full Service	24 months/ 2000 hours	18 months/ 3000 hours	12 months/ 3000 hours (+ preventative maintenance)
	(continue as above)	(continue as above)	(continue as above)

Service Record

Each inspection and service performed should be recorded on the Service Record Sheet found at the back of this manual.

Preventative Maintenance

Refer to the previous page for checks that should be carried out daily/weekly on the unit. Please work with your Dealer in order to create a maintenance schedule which fits your needs.

Thermo King has extended the limited warranty on new units from 3,000 total hours to a maximum of 4,000 compressor run hours within the 2 year warranty period.

This limited warranty is dependent on the owner and/ or operator adhering to the preventative maintenance schedule as advised by your Thermo King Dealer.

Serial Number Locations

1. **CONDENSER:** Nameplate located on the front inside edge of condenser frame (Cover needs to be removed).
2. **STANDBY COMPRESSOR:** 20 and 50 Models only. Nameplate located on standby compressor body. Standby compressor is located inside the Condenser.

Figure 12. Condenser and Standby Compressor Serial Number Locations

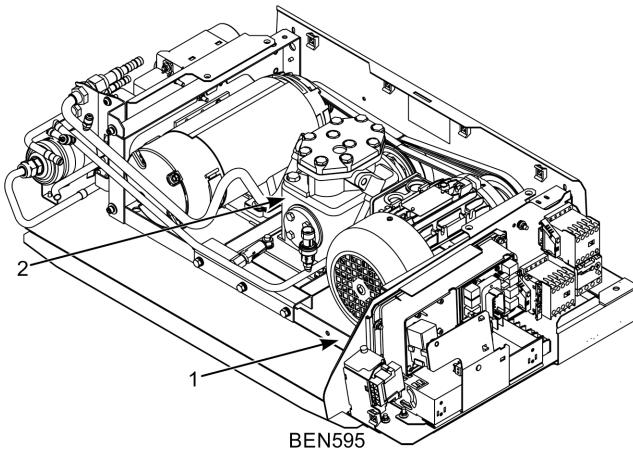

Recover Refrigerant

At Thermo King®, we recognize the need to preserve the environment and limit the potential harm to the ozone layer that can result from allowing refrigerant to escape into the atmosphere.

We strictly adhere to a policy that promotes the recovery and limits the loss of refrigerant into the atmosphere.

In addition, service personnel must be aware of Federal regulations concerning the use of refrigerants and the certification of technicians. For additional information on regulations and technician certification programs, contact your local THERMO KING dealer.

Thermo King – by Trane Technologies (NYSE: TT), a global climate innovator – is a worldwide leader in sustainable transport temperature control solutions. Thermo King has been providing transport temperature control solutions for a variety of applications, including trailers, truck bodies, buses, air, shipboard containers and railway cars since 1938. For more information, visit www.thermoking.com or www.tranetechnologies.com.

Thermo King has a policy of continuous product and product data improvements and reserves the right to change design and specifications without notice. We are committed to using environmentally conscious print practices.